

INSTALLATION ACCESSORIES

HOLLY, HALISSA AND MEMO FORMWORK	270
ACSO AND ACRUX SERIES FORMWORK	270
ACSO AND ACRUX SERIES RING	270
DEHO AND DARDO FORMWORK	271
DEHO AND DARDO SERIES RING	271
PAD FORMWORK	271
REMOVE PLUS FORMWORK	272
REMOVE MINUS FORMWORK	272
DUVAR BASE AND STAKE	272

HOLLY, HALISSA AND MEMO FORMWORK

Thermoplastic formwork for HOLLY, HALISSA and MEMO series models for use during installation. Can be installed in brick walls or floors. Necessary for correct installation.

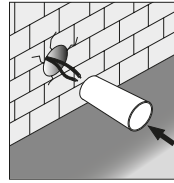
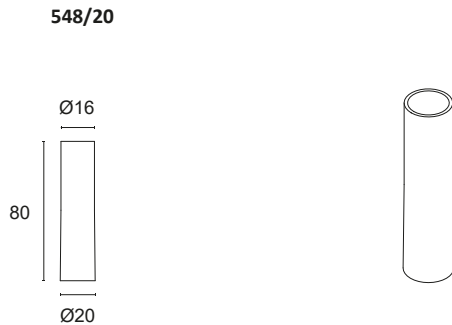

Position the formwork flush with the wall or floor.

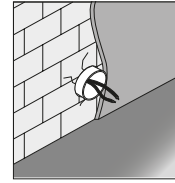

Fix the formwork with glue or putty and level it flush with the wall or floor. Prevent foreign bodies from entering the formwork.

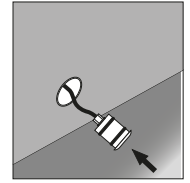

Connect the electricals as stipulated in the product sheet and check it works correctly. Insert the product into the formwork using light pressure.

ACSO AND ACRUX SERIES FORMWORK

Thermoplastic formwork for ACSO and ACRUX series models for use during installation. Can be installed in brick walls or floors. Necessary for correct installation.

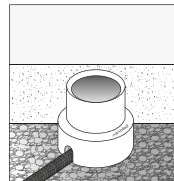
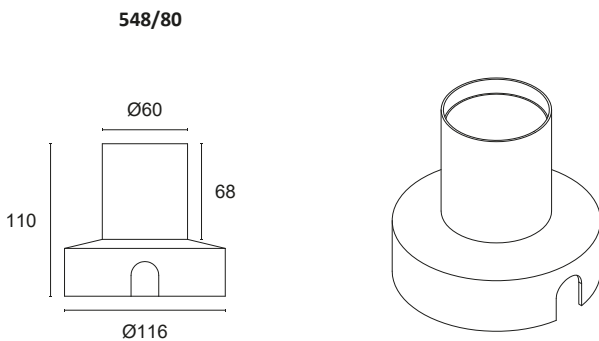

Position the formwork with the top flush with the wall or floor. Apply the supplied cap to prevent foreign bodies from entering the interior. Make sure there is adequate drainage under the formwork.

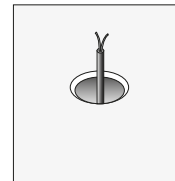

Check that the formwork does not move when laying the screed. Route the electrical cable from the formwork to the shaft. Close the formwork with the cap provided.

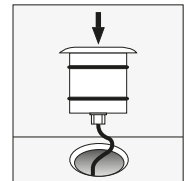

After plastering, remove the cap and connect the electricals according to the product sheet, check that it works properly and insert it into the formwork with light pressure.

ACSO AND ACRUX SERIES RING

Aluminium ring for ACSO and ACRUX series models for use during flush fitting in plasterboard.

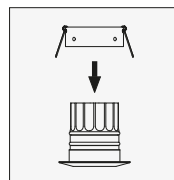
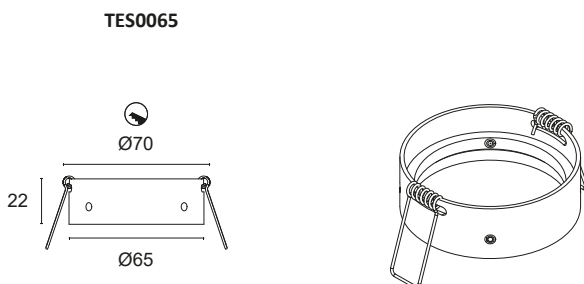

Place the ring in the spotlight.

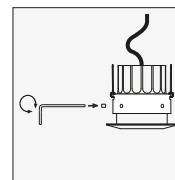

Secure the ring with the supplied grub screws.

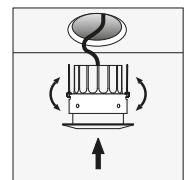

Drill the plasterboard to the indicated size and insert the spotlight into the hole.

DEHO AND DARDO FORMWORK

Thermoplastic formwork for DEHO and DARDO series models for use during installation. Can be installed in brick walls or floors. Necessary for correct installation.

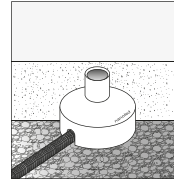
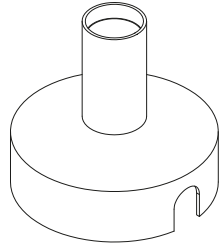
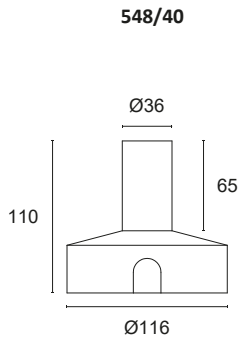

Position the formwork with the top flush with the wall or floor. Apply the supplied cap to prevent foreign bodies from entering the interior. Make sure there is adequate drainage under the formwork.

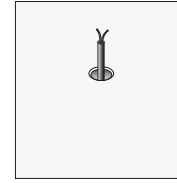

Check that the formwork does not move when laying the screed. Route the electrical cable from the formwork to the shaft. Close the formwork with the cap provided.

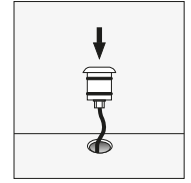

After plastering, remove the cap and connect the electricals according to the product sheet, check that it works properly and insert it into the formwork with light pressure.

DEHO AND DARDO SERIES RING

Aluminium ring for DEHO and DARDO series models for use during flush fitting in plasterboard.

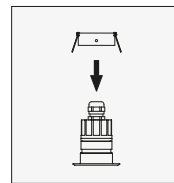
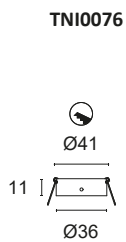

Place the ring in the spotlight.

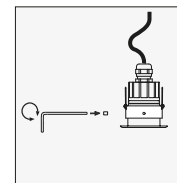

Secure the ring with the supplied grub screws.

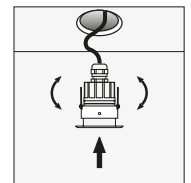

Drill the plasterboard to the indicated size and insert the spotlight into the hole.

PAD FORMWORK

Metal formwork for the PAD model for use during installation. Can be wall mounted on stone, brick or plasterboard. Necessary for correct installation.

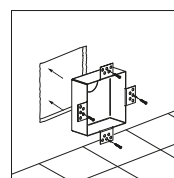
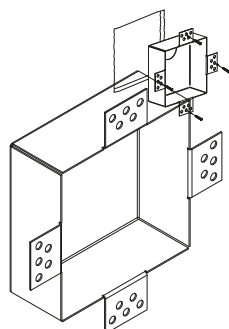
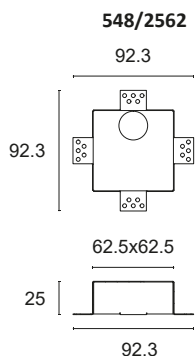

Insert the housing for the formwork and fix it with glue, putty or screws.

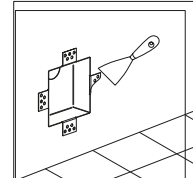

Finish off the edges of the formwork and prevent foreign bodies from entering the formwork. Route the electrical cable from the formwork to the shaft or to the shunt box.

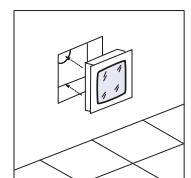

Connect the electricals according to the product sheet, check that it works properly and insert it into the formwork using light pressure.

REMOVE PLUS FORMWORK

Metal formwork for the REMOVE PLUS model for use during installation. Can be wall mounted on stone, brick or plasterboard. Necessary for correct installation.

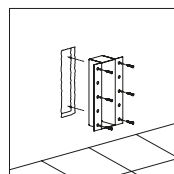
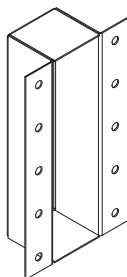
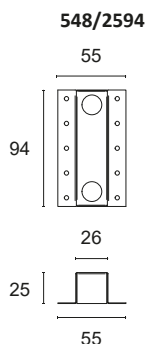

Insert the housing for the formwork and fix it with glue, putty or screws.

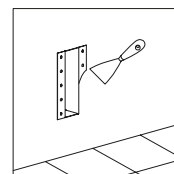

Finish off the edges of the formwork and prevent foreign bodies from entering the formwork. Route the electrical cable from the formwork to the shaft or to the shunt box.

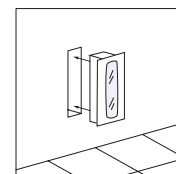

Connect the electricals according to the product sheet, check that it works properly and insert it into the formwork using light pressure.

REMOVE MINUS FORMWORK

Metal formwork for the REMOVE MINUS model for use during installation. Can be wall mounted on stone, brick or plasterboard. Necessary for correct installation.

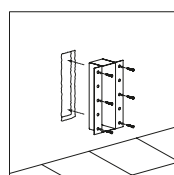
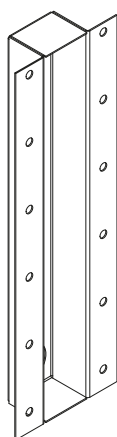
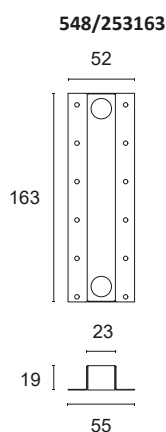

Insert the housing for the formwork and fix it with glue, putty or screws.

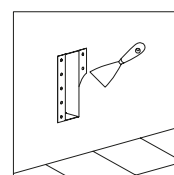

Finish off the edges of the formwork and prevent foreign bodies from entering the formwork. Route the electrical cable from the formwork to the shaft or to the shunt box.

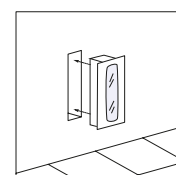

Connect the electricals according to the product sheet, check that it works properly and insert it into the formwork using light pressure.

DUVAR BASE AND STAKE

Mounting systems for DUVAR projector, necessary for correct installation.

TES0039

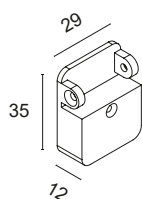

Fixing base

Box

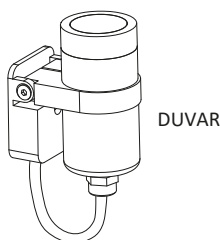

DUVAR

PDH235

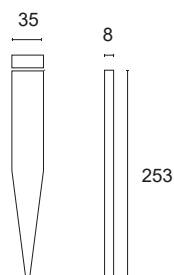

Fixing stake

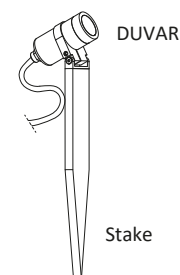

Stake